

# D1 4K HDMI/3G-SDI Decoder

## User Manual



CONTENTS

- 1. Product Preparation..... - 1 -
  - 1.1. Overview..... - 1 -
  - 1.2. Introduction..... - 2 -
  - 1.3. Technical Specifications..... - 3 -
  - 1.4. Packing List..... - 4 -
  - 1.5. Interface Description..... - 4 -
- 2. Installation and connection of equipment..... - 5 -
  - 2.1. Unpacking and inspection of equipment..... - 5 -
  - 2.2. Preparing the connection material..... - 5 -
  - 2.3. Connecting the power supply..... - 6 -
  - 2.4. Connecting a video source..... - 6 -
  - 2.5. Connect to the network..... - 7 -
  - 2.6. Connecting audio (optional)..... - 7 -
  - 2.7. Checking Connections..... - 8 -
- 3. Indication and operation of the LCD screen..... - 8 -
  - 3.1. Turn on the device..... - 8 -
  - 3.2. Preview status..... - 9 -
    - 3.2.1. Preview interface switching..... - 9 -
  - 3.3. System status..... - 9 -
    - 3.3.1. Home Status Setting..... - 10 -
  - 3.4. Outputs..... - 12 -
  - 3.5. Wired Network Lan1..... - 12 -

- 3.5.1. Wired Network Lan1 Setup ..... - 13 -
- 3.6. Wired Network Lan2..... - 14 -
  - 3.6.1. Wired Network Lan2 Setup ..... - 14 -
- 4. Webpage Management and Configuration ..... - 15 -
  - 4.1. Logging in ..... - 15 -
  - 4.2. Dashboard..... - 16 -
  - 4.3. Advanced..... - 19 -
    - 4.3.1. Analog audio..... - 20 -
    - 4.3.2. OSD overlay ..... - 20 -
  - 4.4. Network ..... - 21 -
    - 4.4.1. Wired Network 1 ..... - 21 -
    - 4.4.2. SNMP..... - 22 -
  - 4.5. Setting ..... - 23 -
    - 4.5.1. Management platform ..... - 24 -
    - 4.5.2. User management ..... - 25 -
    - 4.5.3. Time and zone ..... - 26 -
    - 4.5.4. Systems..... - 27 -
- 5. Support..... - 30 -

# 1. Product Preparation

## 1.1. Overview

Thanks for purchasing CNDLive X1 Encoder! CNDLive is a subsidiary of CND Electronics Technology Co., Ltd, which was found in 2006, Shenzhen. We have been dedicated to innovation and development of hardware and software in Smart Information Interactive Industry. We are excellent at information display, intelligent dual-touch, biometric special processing and HD remote real-time transmission technology.

With these full experiences, CNDLive will focus on IP based video and audio transmission. We develop an extensive range of solutions for the professional video and audio market, from video encoding, decoding to conversion, either by Ethernet, Wi-Fi and 4G/5G bonding, with full protocols including Full NDI, NDI|HX, SRT, RTMP and more.

CNDLive is committed to bringing professionals high quality and most reliable gear in the field.

We hope that this manual will help you get started quickly and take full advantage of the powerful features of X1 bonding encoder. If you have any questions or need assistance while reading and using this manual, please feel free to contact our technical support team via [support@cndlive.com](mailto:support@cndlive.com)

Thank you for choosing CNDLive and we look forward to making your work more convenient and efficient.

## 1.2. Introduction

The D1 Decoder is a high-performance device from CND Live for the professional video and audio market. It is designed for decoding and converting Ultra HD video signals, and supports a wide range of video output formats, including HDMI and SDI, ensuring a high-quality video experience in a variety of application scenarios.

### Key Benefits

#### Powerful decoding capacities to meet various high-end video decoding needs

- ❖ Supports H.264, H.265 and NDI standard decoding
- ❖ Supports 1CH 4Kp60 or 4CH 1080p60 decoding under NDI Full Bandwidth while 2CH 4Kp60 or 8CH 1080p60 decoding under H.264/H.265
- ❖ Decodes interlaced sources to better support traditional applications
- ❖ Rich audio decoding capabilities, supporting standards such as AAC, MP3, G.711, and SDI/HDMI 8 channels audio decoding

#### Support the most common protocols, Web preview and multi-view display

- ❖ Supports NDI|HB and NDI HX2, easy access to your NDI system
- ❖ Supports to decode SRT, RTMP, RTMPS, HLS, TS over UDP, RTSP
- ❖ Supports Web preview in multi-view and up to 4-channel preview

#### Built-in LCD screen for easy configuration and realtime preview

- ❖ 2" LCD screen allows you to preview the realtime sources
- ❖ Easy configuration and check working status, network conditions and other data

## Other features

- ❖ Supports RTMP server
- ❖ Supports image and text overlay
- ❖ 2x10/100/1000M RJ45 Ethernet ports and one with PoE
- ❖ Supports remote device management

## 1.3. Technical Specifications

Model	D1
Video Interfaces	<p>1×3G-SDI (SMPTE 424M), HD-SDI (SMPTE 292M) and SD-SDI (SMPTE 259M)</p> <p>1x HDMI 2.0</p>
Decoding Outputs	<p><b>SDI:</b></p> <p>SDI 1080P: 1920x1080P60, 1920x1080P59.94, 1920x1080P50                      1920x1080P30, 1920x1080P29.97, 1920x1080P25, 1920x1080P24,                      1920x1080P23.98</p> <p>SDI 1080i: 1920x1080i60, 1920x1080i59.94, 1920x1080i50</p> <p>SDI 720p: 1280x720P60, 1280x720P59.94, 1280x720P50</p> <p><b>HDMI:</b></p> <p>HDMI 4k: 3840x2160P60, 3840x2160P50, 3840x2160P30, 3840x2160P25,                      3840x2160P24</p> <p>HDMI 1080P: 1920x1080P60, 1920x1080P59.94, 1920x1080P50,                      1920x1080P30, 1920x1080P29.97, 1920x1080P25, 1920x1080P24,                      1920x1080P23.98</p> <p>HDMI 1080i: 1920x1080i60, 1920x1080i59.94, 1920x1080i50</p> <p>HDMI 720P and below: 1280x720P60, 1280x720P59.94, 1280x720P50                      720x576P50 and 720x480p60</p>

Audio Ports	1× 3.5mm LINE OUT
Decoding Protocols	NDI High Bandwidth, NDI HX2, SRT, RTMP, RTMPS, HLS, TS over UDP, RTSP, RTMP server
Network Ports	2×/100M/1000M (With 1xPoE)
Other Ports	1×USB-A 3.0 and 1xType-c
LCD Screen	2.0" LCD screen and buttons
Management	Web UI/Remote Management Platform
Power Consumption	≤9W
Power Supply	DC 12V/1A
Working Temperature	-10°C~45°C (Storage temperature -20°C~45°C)

## 1.4. Packing List

Item	Unit	QTY
Device	PCS	1
Power Adapter	PCS	1
Warranty Card/Certificate	PCS	1
Quick Start Guide	PCS	1

## 1.5. Interface Description



- |                         |                                  |           |
|-------------------------|----------------------------------|-----------|
| 1. Line Out             | 2. USB-A 3.0                     | 3. Type-C |
| 4. 2-inch LCD screen    | 5. UP                            | 6. OK     |
| 7. DOWN                 | 8. Power Switch                  | 9. DC Out |
| 10. HDMI Output         | 11. 1000M Ethernet port with PoE |           |
| 12. 1000M Ethernet port | 13. SDI Output                   |           |

## 2. Installation and connection of equipment

### 2.1. Unpacking and inspection of equipment

Before starting the installation, make sure that the equipment packaging is intact.

Open the package and check that the device and its accessories are complete, including the power adapter, Quick Start Guide, etc.

### 2.2. Preparing the connection material

Make sure you have all the necessary connection cables, including the power



adapter, Ethernet cable, and HDMI or SDI video cable.

## 2.3. Connecting the power supply

Connect D1 decoder to a power port. Make sure that the voltage and frequency of the power adapter correspond to local standards.

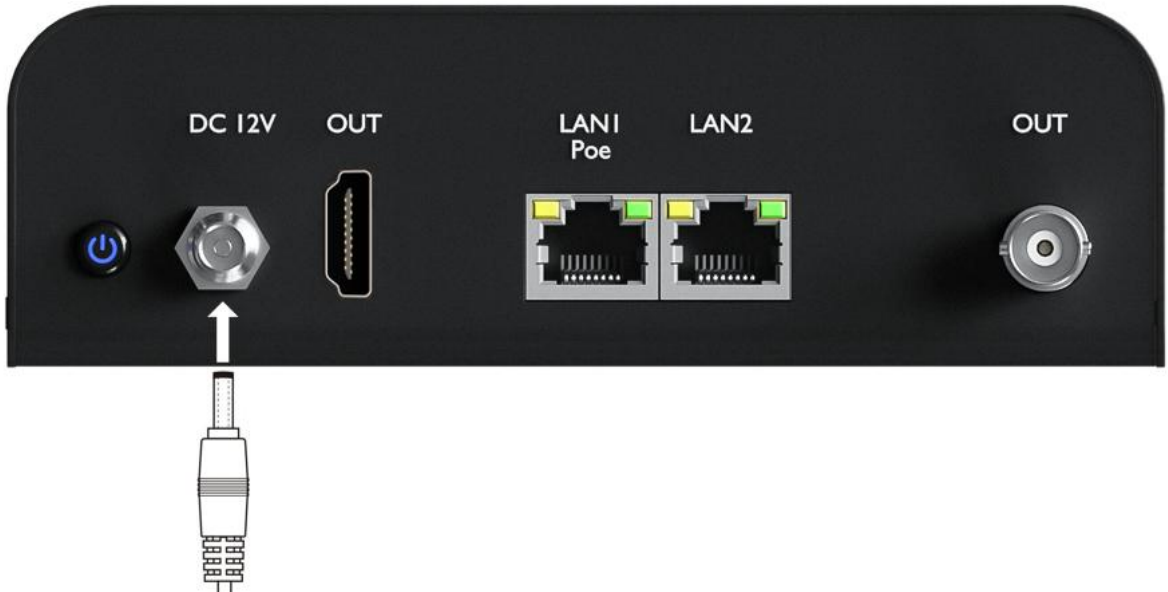

## 2.4. Connecting a video source

Use an HDMI or SDI cable to connect your display device (e.g. monitor) to the HDMI or SDI output connector. Make sure that the connectors on both ends match and are securely connected.

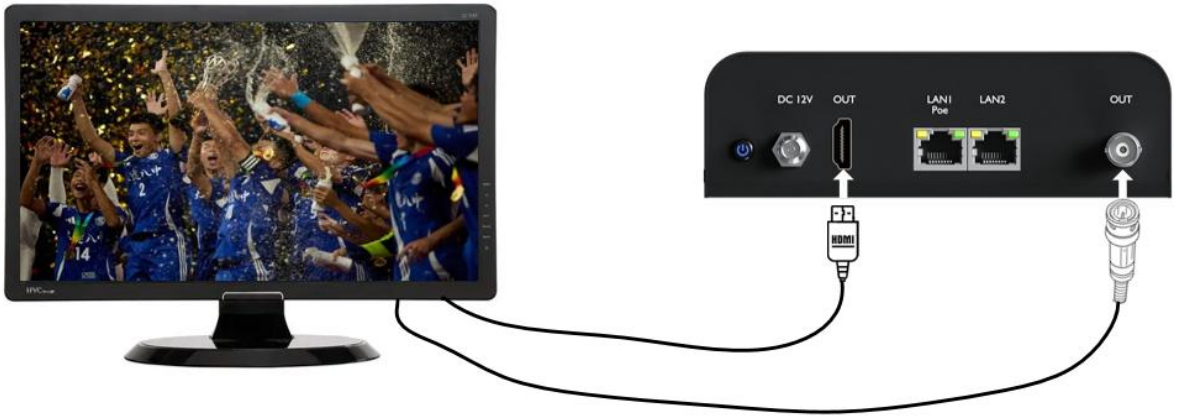

## 2.5. Connect to the network

Connect the 1000M RJ45 Ethernet port of the D1 to your LAN or the Internet by an Ethernet cable. Ensure that your network supports DHCP to automatically assign an IP address to the decoder.

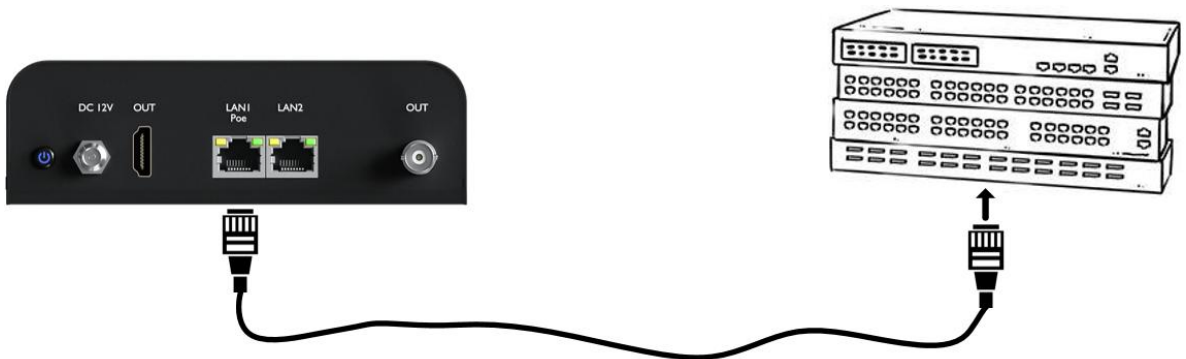

The first time you use D1, your network needs to include a DHCP server in order to obtain an IP address from the DHCP server. If you need a fixed IP address, you can manually assign a static IP address to the D1 decoder by logging into the D1's web management via the DHCP-assigned address.

- When configuring your network, make sure that your network configuration does not conflict with the IP address of the D1 decoder or other network devices.
- If PoE power is required, please plug into the network port with PoE logo on the left side corresponding to D1.

## 2.6. Connecting audio (optional)

If desired, an audio playback device can be connected to the LINE OUT connector using a 3.5mm audio cable.

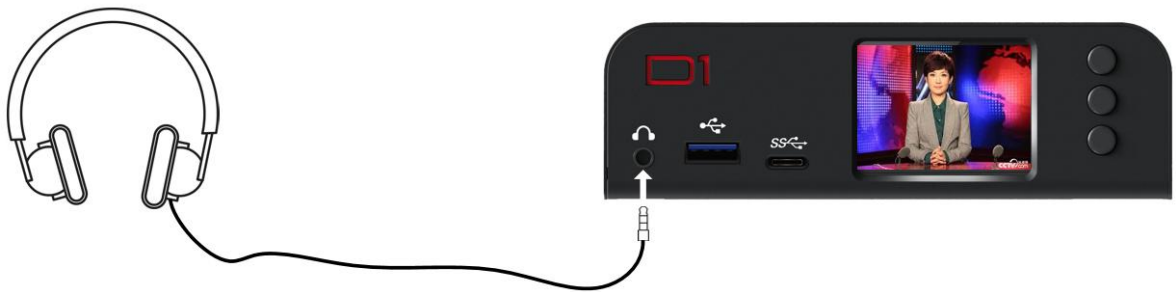

### **The LINE OUT connector applies to the device:**

**Headphones:** Users can plug headphones directly into the LINE OUT connector to privately monitor the audio content being decoded.

**Audio Receiving Devices:** The output of the LINE OUT connector can be connected to audio interfaces, mixing consoles, or other audio processing devices for further processing or amplification of the audio signal.

**PA System:** If you need to play audio in a larger space, you can connect the LINE OUT connector to the audio input of your PA system.

**Recording Devices:** The LINE OUT connector can be connected to a recording device, such as a digital audio workstation (DAW) or portable recorder, to record high quality audio.

## **2.7. Checking Connections**

After all connections have been made, check that each cable and connector is securely connected to ensure that there are no loose or damaged connections.

# **3. Indication and operation of the LCD screen**

## **3.1. Turn on the device**

Turn on the device on the rear panel.

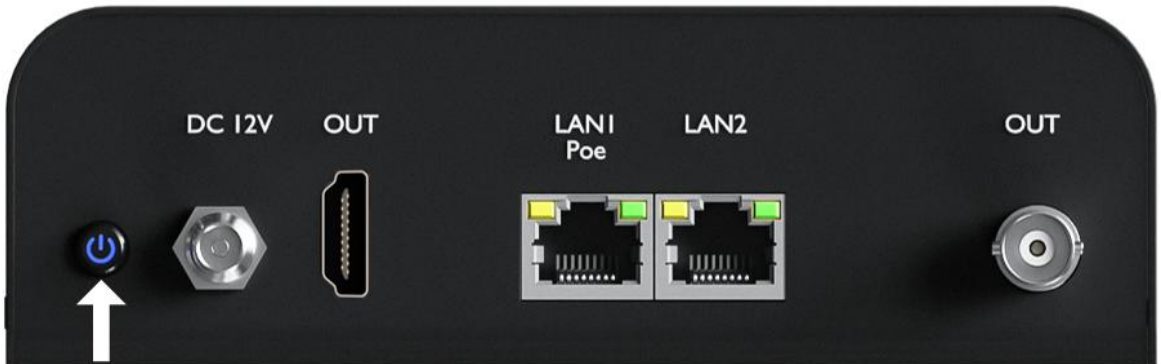

Observe the LCD display on the front panel of the unit to ensure that the unit boots up properly and acquires an IP address.

## 3.2. Preview status

The D1 decoder is equipped with a LCD screen that provides a real-time preview of the source, ensuring that you can monitor and confirm the status of the output signal.

When you turn on the D1 decoder, the device will automatically enter the preview state.

### 3.2.1. Preview interface switching

The preview interface is same as the decoding interface you are currently selecting. You can switch the interface of the decoding, via the Webpage or the LCD screen.

- By default, the LCD screen displays the screen of the HDMI signal source. If the HDMI port does not detect a signal, the LCD screen will display in blue.
- If you switch to SDI interface, the LCD screen will display the SDI source. If the SDI interface does not detect a signal, the LCD screen will display in blue.
- Make sure that the preview interface you select matches the input signal source.
- If the preview screen appears abnormal, check the connection status of the signal source or switch to another decoding interface.

## 3.3. System status

The front page of LCD panel is the current operating status of the unit, which includes the following key information:

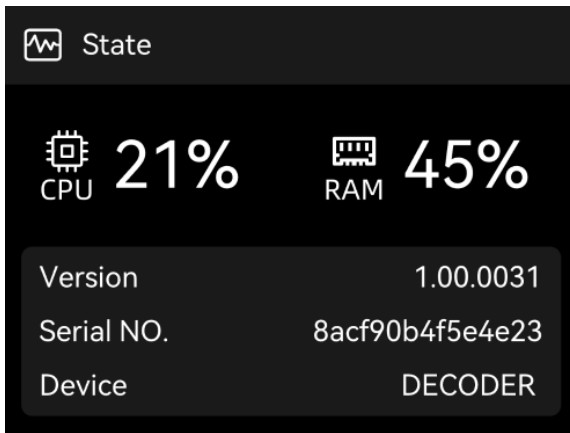

**CPU and memory consumption:** Displays the current CPU and memory usage in percentage. This data helps you monitor the performance and resource allocation of your device.

**Version number:** Displays the current software version of the device. This version number is important for technical support and software upgrades.

**Serial number:** Displays the serial number of the current device. This is a unique identifier used for device registration and troubleshooting.

**Device name:** Displays the name of the current device setting. You can change this name in the Webpage. The device name is mainly used for the device name of the NDI stream and the device name displayed by the CNDLive Manager, so make sure to set a name that is easy to recognize.

- **Up button:** This button allows the user to scroll up through the device's setup menu or information display.
- **Confirmation key:** Used to confirm the user's selection or to enter the selected setup menu.
- **Down button:** This button allows the user to scroll down in the device's setup menu or information display.

### 3.3.1.Home Status Setting

In [System Status](#) menu pressing OK<sup>⏏</sup> will take you to the system setup page.

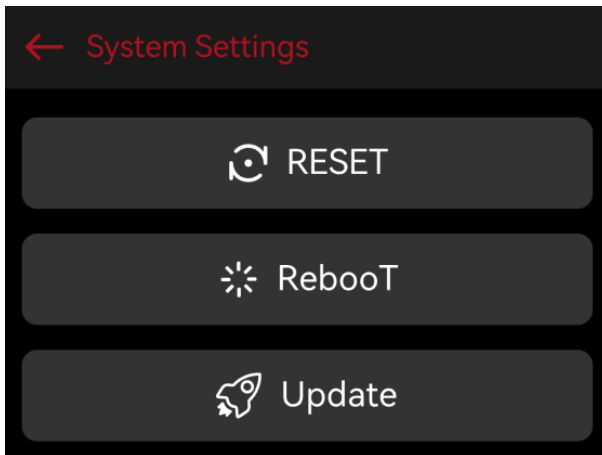

**System settings:** Pressing the OK button in this area will return you to the previous menu.

**Reset:** Selecting this option will perform a restore to factory settings. This will erase all user configurations and restore the device to its initial state. Please proceed with caution as this will be irreversible.

 **Note**

Before performing the reset operation, please make sure you have backed up all important information to prevent data loss. If you need further help or guidance, please contact technical support.

**Reboot:** Selecting this option will reboot the device. This will turn the device off and then turn it back on and is typically used to apply changes or resolve temporary issues.

**Update:** First, make sure you have inserted the USB disk containing the D1 software file (.bin file) into the USB port of the device. The software file should be placed in the root directory of the USB disk.

On the LCD screen, press the "Update" option. The device will automatically check if the software file for the D1 exists in the root directory of the USB disk.

1) If the D1 detects the correct software file, the screen will display a message asking if you want to continue with the update process. Otherwise, the update will be aborted with the message "no matching software found".

2) If D1 detects multiple versions of software for the same model, the latest software will be used automatically.

Confirm update: Select the continue option to begin the software update.

Update progress: The LCD screen will show the progress of the software update. When the update is complete, the device will automatically reboot.

### **Note**

- Do not disconnect the power or turn off the device during the update process as it may cause the update to fail.
- Be sure to update the software for the correct device model.
- This update via USB disk is normally used while Webpage is not working.

## 3.4. Outputs

In [Home Status](#) menu pressing the down▽ key will enter the output display.

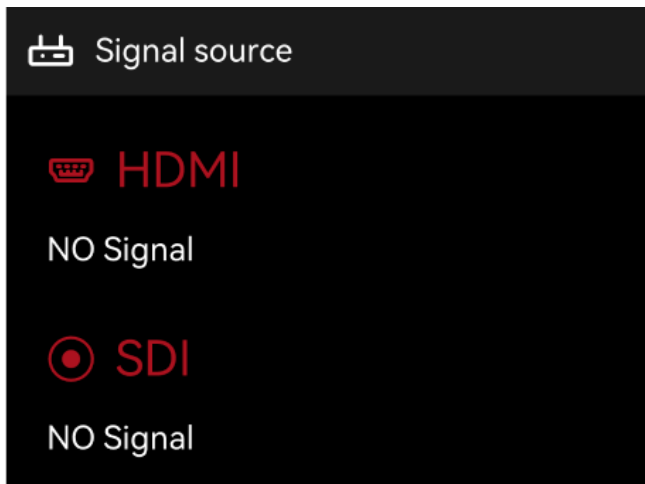

**HDMI:** Displays information about the connected HDMI signal, including resolution, frame rate, and audio sample rate. This data is essential to confirm that the HDMI source is configured and operating correctly. If no HDMI signal is currently connected, this area will display "No Signal".

**SDI:** Displays information about the accessed SDI signal, including resolution, frame rate, and sample rate. This data is critical to confirm that the SDI source is configured and operating correctly. If no SDI signal is currently connected, this area will display "No Signal".

## 3.5. Wired Network Lan1

In [Signal Source](#) menu press the down ▾ key, which will take you to the wired network Lan1 menu.

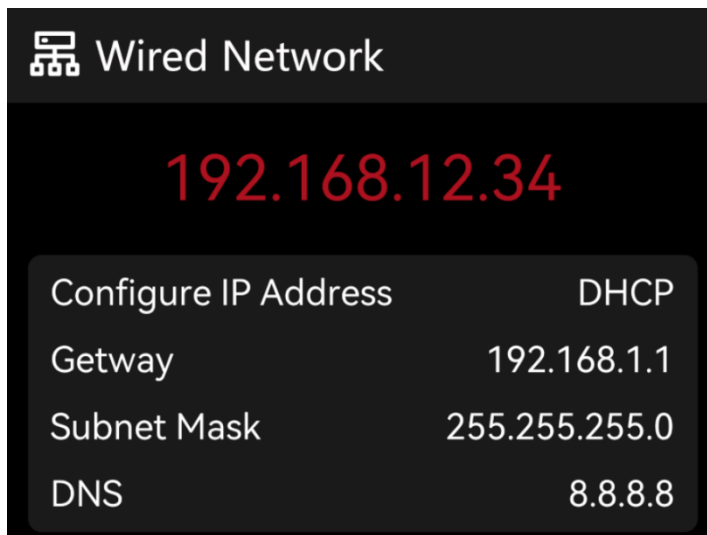

**Network type indication:** Shows the type of network the device is currently connected to, wired connection 1 or wired connection 2.

**IP address display:** This area displays the IP address of the device in the current network, which is used to identify and access the device.

**Network configuration mode:** This area indicates whether the device uses Dynamic Host Configuration Protocol (DHCP) to obtain network parameters automatically, or whether it uses manual setting of network parameters.

**Gateway information:** Displays the default gateway address of the current network, which is the exit point for the device to communicate with other devices in the network or external network.

**Subnet mask information:** Displays the subnet mask of the current network, which helps the device to determine the local and external communications in the network.

**DNS server information:** Displays the IP address of the Domain Name System (DNS) server being used by the device to resolve domain names to IP addresses.

### 3.5.1. Wired Network Lan1 Setup

Pressing OK  from the Wired Network Lan1 menu will take you to the wired network lan1 setup page.



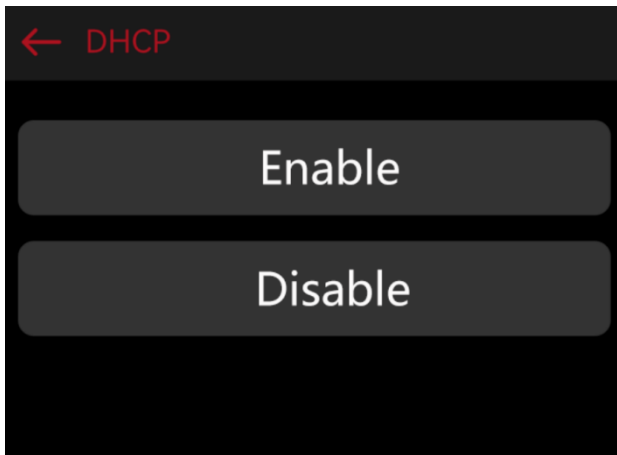

1) **DHCP:** Displays the title of the current network DHCP mode. Pressing the OK button in this area will return you to the previous menu.

2) **On:** This option is used to enable Dynamic Host Configuration Protocol (DHCP) mode for the current network so that the device can obtain an IP address automatically. If the mode is already on, there will be no effect selecting this option.

3) **Disable:** This option is used to disable the Dynamic Host Configuration Protocol (DHCP) mode for the current network and switch to static IP settings. Selecting this option will have no effect if the mode is already disabled.

### **Note**

To set specific static IP address, subnet mask, gateway and DNS server values, you will need to set them manually in the Webpage.

## **3.6. Wired Network Lan2**

When you press the Down key in the Wired Network Lan1 menu, you will enter the Wired Network Lan2 menu, which has the same functions and options as Lan1.

### **3.6.1.Wired Network Lan2 Setup**

Pressing OK<sup>Ⓚ</sup> from the Wired Network Lan2 menu will take you to the Wired Network Lan2 Settings page.

This page has the same features and options as the Wired Network Lan1 Setup

page.

## 4. Webpage Management and Configuration

### 4.1. Logging in

Ensure that the D1 decoder is properly connected to a DHCP-enabled network, and power up the unit on the rear panel.

The device will automatically attempt to obtain an IP address from the network. Observe the LCD display on the front panel of the unit and press the Down button until you see the "Wired Network" message, which will display the wired network information, including the IP address.

Open a Web browser on a computer connected to the same network as the D1 decoder.

It is recommended to use Chrome and update to the latest version for compatibility with the D1 decoder's administration page.

Enter the IP address obtained by D1 LCD screen in your browser.

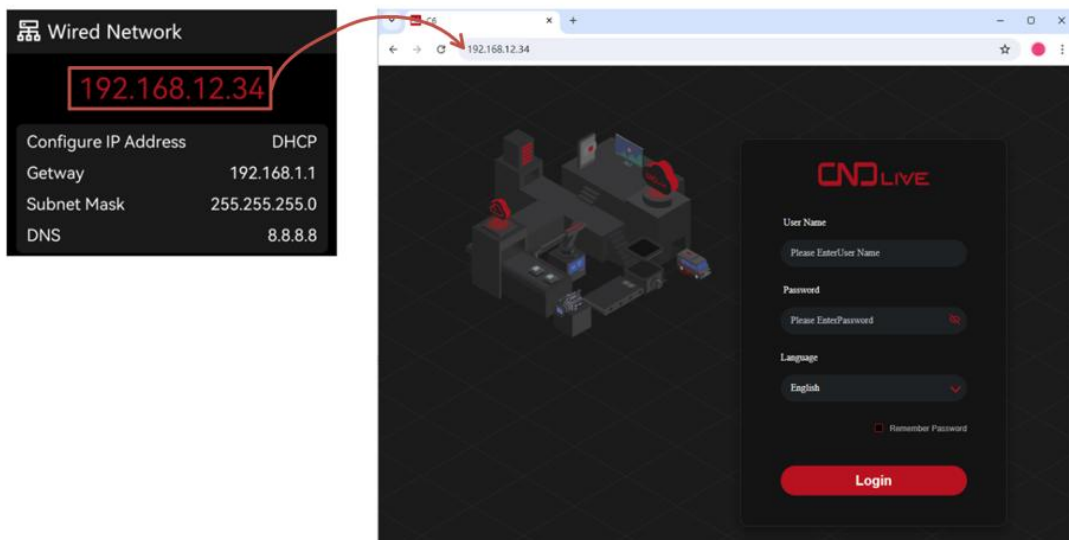

Enter the default username and password both are ***admin***.

Click Login or press Enter to go to the Webpage of the D1 decoder.

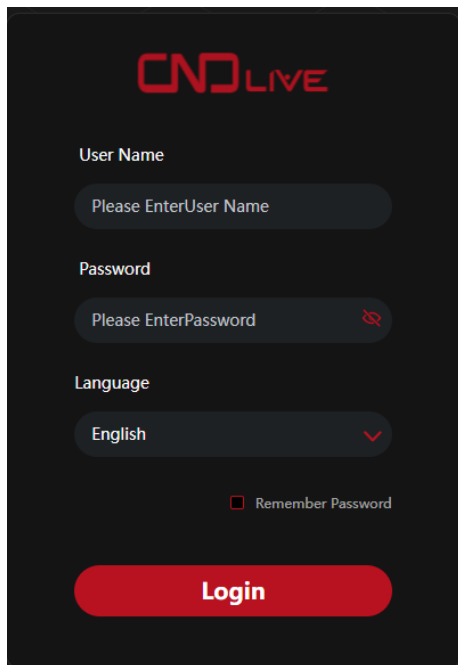

CND LIVE

User Name

Please EnterUser Name

Password

Please EnterPassword

Language

English

Remember Password

Login

## 4.2. Dashboard

Dashboard is the central platform for you to play with your device. Designed to provide an efficient and intuitive page, it enables users to easily monitor device status, configure the network, manage video sources, adjust decode output settings, and perform user management and system maintenance to ensure stable operation and optimal performance of the device.

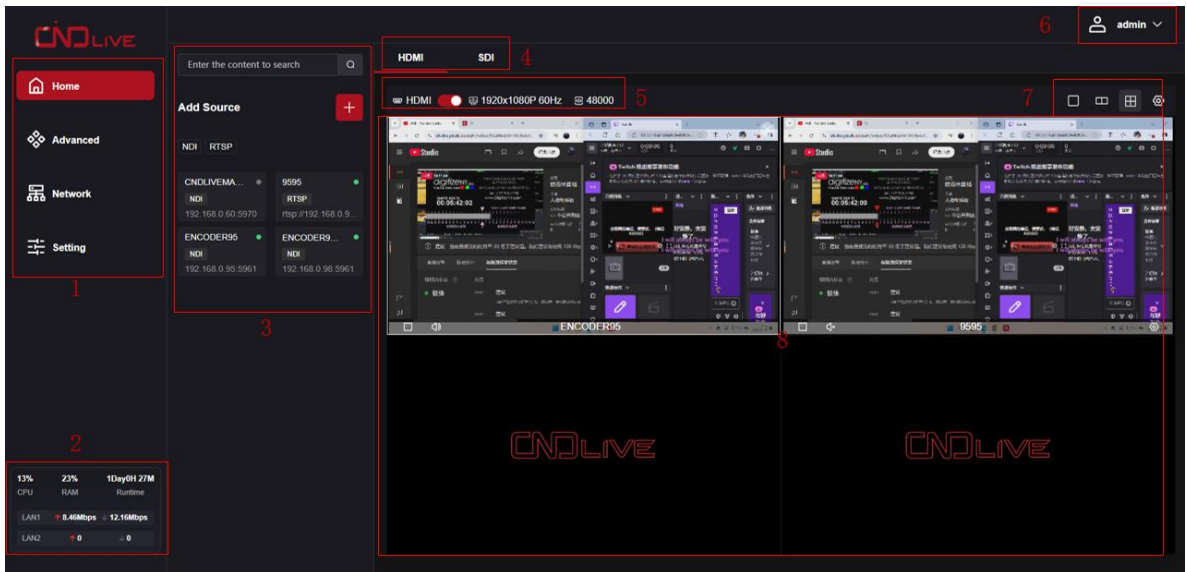

### 1) Left menu:

**Home:** Click to go to the home page of the device, where you can view an overview of the device's status and basic configuration information.

**Advanced:** Here you can access advanced feature configurations such as analog audio output settings, OSD management and more.

**Network:** Network settings allow you to configure wired network (Lan1 and Lan2) network parameters, as well as the SNMP protocol.

**Settings:** In the Settings menu, you can manage device information, system maintenance, user management, time and zones, etc.

**2) System Status:** The System Status area provides key equipment performance indicators.

CPU usage: Shows the current CPU usage.

Memory consumption: Shows the current memory usage.

Device runtime: Shows how long the device has been running since it was powered on and started.

Bandwidth consumption: Displays the upload and download bandwidth usage for both network interfaces.

### 3) Source list area:

Add source: Click the + button to add a new video source, currently supports RTSP,

SRT, RTMP/RTMPS, RTMP Server, HLS, UDP, NDI|HX, NDI Full Bandwidth.

Search added sources: Search and manage added video sources.

Show added sources: View and manage a list of all added video sources.

Source filtering display: Filter the display of video sources according to the streaming protocol.

**4) Decoding interface selection:** You can choose HDMI or SDI as the decoding output.

**5) Interface status display:** You can operate the decoder interface switch, view the current setting resolution, frame rate and audio sample rate information.

**6) Login avatar:** Displays the current login username and allows you to switch the language of all pages.

**7) Decoder output settings:** You can operate multi-window switching and decoder settings as follows:

**Multi-Window switching:** This feature allows users to choose how the video output is laid out, such as single window, double window, quad window, etc. Multi-window switching is suitable for scenarios where multiple video sources need to be viewed at the same time, such as surveillance centers or TV walls.

**Resolution:** The resolution setting determines the sharpness of the video output. i stands for interlaced and P stands for progressive. Interlaced and progressive scanning are two different video scanning methods, and progressive scanning usually provides smoother image quality.

**Decode mode:** The decode mode setting determines how the video signal is decoded. the AUTO mode automatically detects and selects the most suitable decode mode, while the HDMI and DVI modes correspond to the decoding of HDMI and DVI video signals respectively.

**Color space:** The color space setting determines how the video color is encoded. AUTO mode automatically selects the most appropriate color space, RGB is a color encoding method, YUV444, YUV422 and YUV420 are YUV color encoding methods with different compression levels.

**Color range:** The Color Range setting determines the range of video colors to be

displayed. AUTO mode automatically selects the most appropriate color range, LIMITED mode indicates a limited color range, and FULL mode indicates a full color range.

**Audio sample rate:** The audio sample rate setting determines the sample rate for audio playback. Different sample rates affect audio quality and bandwidth requirements. The disable option indicates that the audio output is disabled.

**Number of audio channels:** The number of audio channels setting determines the number of audio channels for audio playback. Mono means there is only one audio channel, and Stereo means there are two independent audio channels, providing a richer listening experience.

8) **Preview window:** Displays the screen of the currently added decoding source, which is convenient for users to monitor the video source status in real time. Adding video sources to the decode preview window is an intuitive operation process. The following are two detailed steps for adding sources:

#### ① **Add by dragging the mouse**

Move the mouse pointer over the added video source.

Long press the left mouse button and drag the video source to the preview window.

Release the left mouse button in the preview window area.

The video source will be automatically added to the preview window and will start displaying the video content.

#### ② **Click the source you want**

First click the decode preview window so that its border turns **white**, indicating that the preview window is selected.

Then click any of the video sources in the list of added video sources.

When clicked, this video source will be automatically added to the preview window and will start displaying the video content.

## 4.3. Advanced

The advanced menu offers advanced setup options to meet the needs of

professional users, the two main options are listed below.

### 4.3.1. Analog audio

This option allows the user to configure the Line Out port of the D1 decoder.

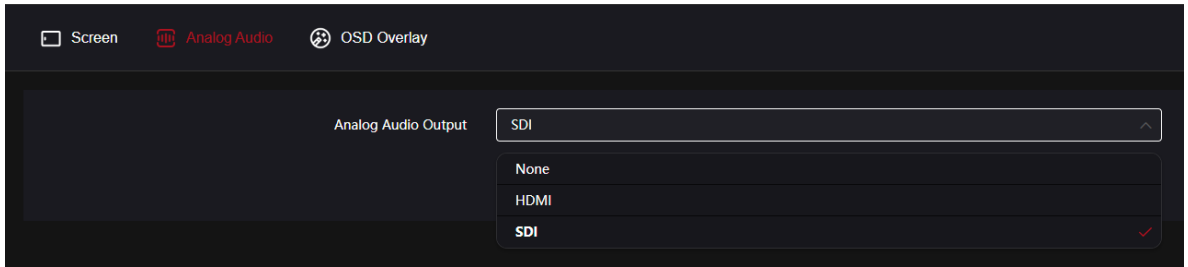

Select "None" to turn off the Line Out.

Selecting "HDMI" or "SDI" means that the corresponding audio signal is output to Line Out.

### 4.3.2. OSD overlay

The OSD (On-Screen Display) overlay feature allows users to add text or image to video output.

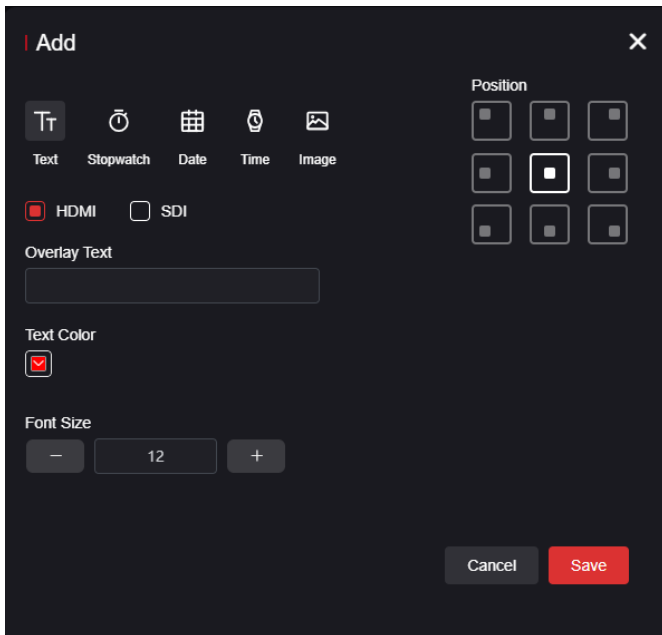

Image upload: Users can upload images in jpeg/jpg/png format with a size of less than 5MB.

OSD List: Users can view, create or delete existing OSD overlays.

Add window: After clicking the add button, users can select the type of overlay in

the add window, including text, stopwatch, date (year, month, day), time (year, month, day, hour, minute, and second), and image.

Overlay position: Users can select the position of the OSD overlay in one of nine directions, including Top Left, Center Left, Top Right, Center Left, Center, Center Right, Bottom Left, Bottom Center, and Bottom Right.

Decode output selection: Users can decide on which decode output port the overlay will take effect by checking HDMI and SDI.

Content editing: Depending on the type of overlay selected, the user can enter text content or select an image. For "Stopwatch", "Date" and "Time", the system displays the default time format.

Further settings: For text, stopwatch, date and time types, the user can set the font color (selected via the color palette or by entering an RGB code) and font size.

Image preview: Users can choose different pictures and positions to preview the actual effect.

## 4.4. Network

D1 provides 2 wired network connections, plus SNMP management.

### 4.4.1.Wired Network 1

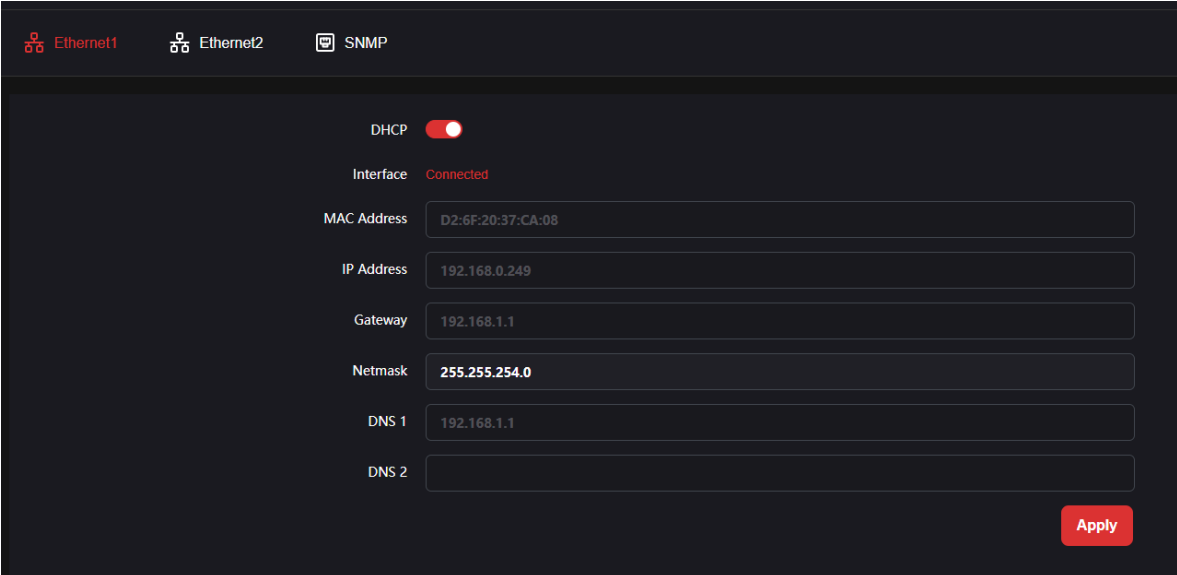

The screenshot shows a network configuration interface for Ethernet1. At the top, there are three tabs: Ethernet1 (selected), Ethernet2, and SNMP. Below the tabs, the DHCP toggle is turned on. The interface is labeled "Connected". The configuration fields are as follows:

Field	Value
MAC Address	D2:6F:20:37:CA:08
IP Address	192.168.0.249
Gateway	192.168.1.1
Netmask	255.255.254.0
DNS 1	192.168.1.1
DNS 2	

An "Apply" button is located at the bottom right of the configuration area.

**Auto obtain:** This option allows the network device to automatically obtain network information such as IP address from a DHCP server on the network. When



this feature is enabled, users cannot manually set the IP address, default gateway, subnet mask, DNS, etc. because these options will be disabled (grayed out).

**MAC address:** Displays the fixed MAC address of the current device, which is necessary information in some network management scenarios, such as when you need to restrict specific devices from accessing the network.

**IP address:** Manually set the IP address of the device, usually used when there is no DHCP service in the network or when a static IP address is required.

**Default gateway:** Set the default gateway address for network egress, packets sent by the device to other networks will be sent to this gateway first.

**Subnet mask:** Defines which portion of the IP address is the network address and which portion is the host address. Subnet masks are used in conjunction with IP addresses to identify a specific network.

**DNS1 and DNS2:** Setting up domain name system (DNS) server addresses for resolving domain names to IP addresses. Usually, one DNS server is required, but in some cases, multiple DNS servers are set up for reliability and speed.

 **Note**

When performing wired network setup, make sure the device is properly connected to the network.

**4.4.2.SNMP**

The D1 provides SNMP (Simple Network Management Protocol) support, allowing administrators to monitor and manage the device over the network. SNMP functionality can be enabled and configured on the Webpage.

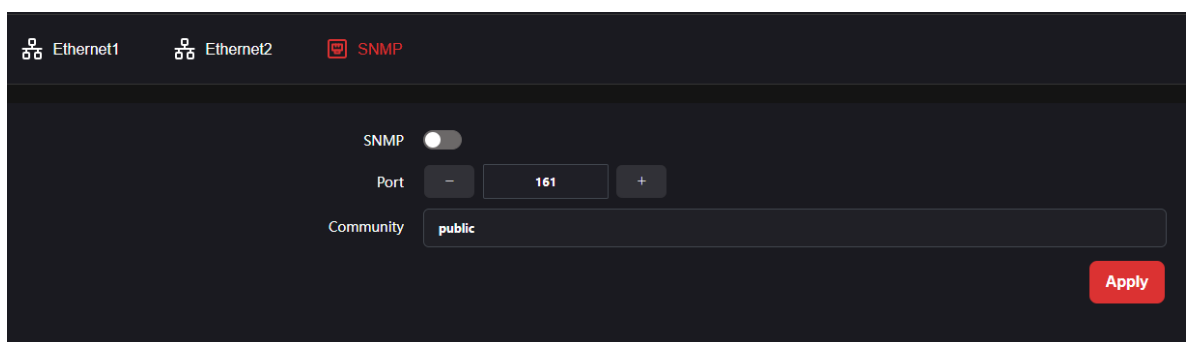

**Enable SNMP :** Click the enable button next to the SNMP function to activate the SNMP function.

**Configure the SNMP port:**

- 1) After the SNMP feature is enabled, you will see port configuration options.
- 2) The desired SNMP port value can be entered manually or the port number can be adjusted using the - or + signs.
- 3) Ensure that the port number you enter matches your network plan and does not conflict with SNMP ports on other devices in your network.

**Set the community name:**

- 1) Security mechanisms used to control access to the device.
- 2) The default team name is "public". For security reasons, it is recommended to change this default setting.
3. Enter a new, secure community name to restrict access to the device.

**Save the configuration:**

1. After completing the SNMP port and community name settings, click the apply button located at the bottom of the configuration screen.
2. The device saves your configuration and may need to restart the SNMP service for the changes to take effect.

**Note**

- Ensure that network firewall rules allow SNMP traffic to pass.
- Consider restricting which IP addresses can access the SNMP port for added security.
- Update your SNMP password or community name regularly to keep your network secure.
- If you are using SNMP on a public network, it is recommended that you use a VPN or other encryption method to protect data transmission.

## 4.5. Setting

The setting menu is a powerful tool for advanced configuration and system management, and includes a connection management platform, user management, time and time zone settings, as well as upgrade and reboot functions to help you optimize device performance and ensure system security.

### 4.5.1. Management platform

The management platform feature provides an intuitive user interface for users to monitor and adjust decoder connection and configuration settings.

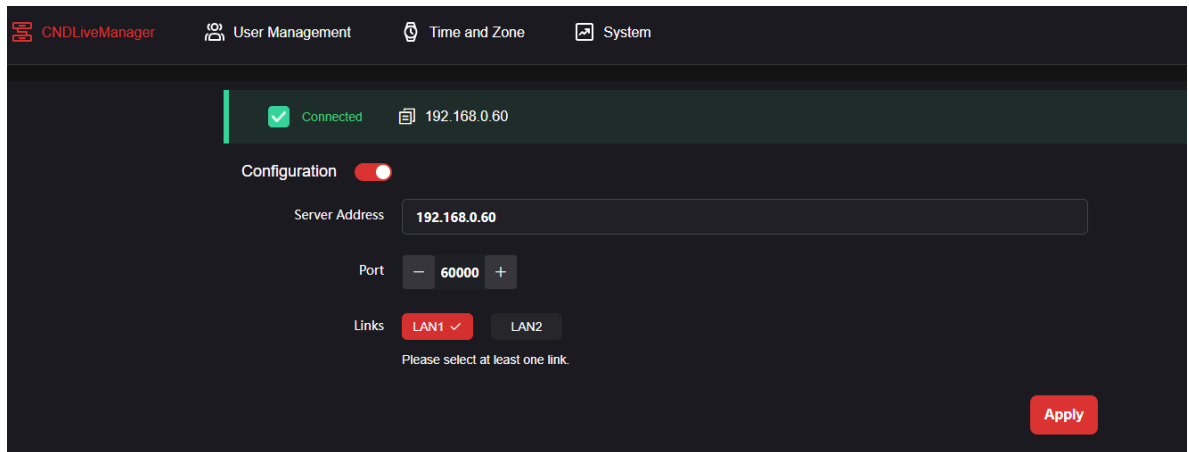

**Connection status:** The "connection status" area on the user interface clearly indicates the connection status between the decoder and the management platform. When the decoder successfully establishes a connection with the management platform, the area will display "connected" to confirm that the communication link is normal.

**Configuration:** The user can activate the current configuration settings by clicking on the "enable configuration" button. This step ensures that the decoder's settings are correctly applied so that it works as expected.

**1) Server address:** The user can enter the IP address of the management platform in the "server address" sub-option. This ensures that the decoder is directed to the correct management server for data exchange and control commands.

**2) Server port:** In the "server port" sub-option, users can manually enter the desired port number, or use the "+" and "-" buttons to increase or decrease the port number value. This provides a convenient way for users to select ports to meet specific network configuration needs.

**3) Data encryption:** In the "data encryption" sub-option, users can choose whether encrypting the transmitted data or not. The options include "no encryption" and "encryption" to ensure that the security of the data transfer meets the user's specific requirements.

**4) Link selection:** Users can select the connection type of the decoder in the

"Links" . You can select "LAN1" or "LAN2" depends on your own needs.

**5) Rate display:** Below the configuration options, the user interface will display a network usage status to visualize the current link's used bandwidth. This feature helps users to monitor the network bandwidth usage in order to optimize network resources and decoder performance.

### **Note**

- Ensure that the network firewall rules allow the corresponding port traffic to pass.
- Regularly update your version of the CNDLive Manager to keep the connection successful and secure.

## 4.5.2. User management

The user management function allows administrators or users with appropriate privileges to add, edit and delete user accounts in the system.

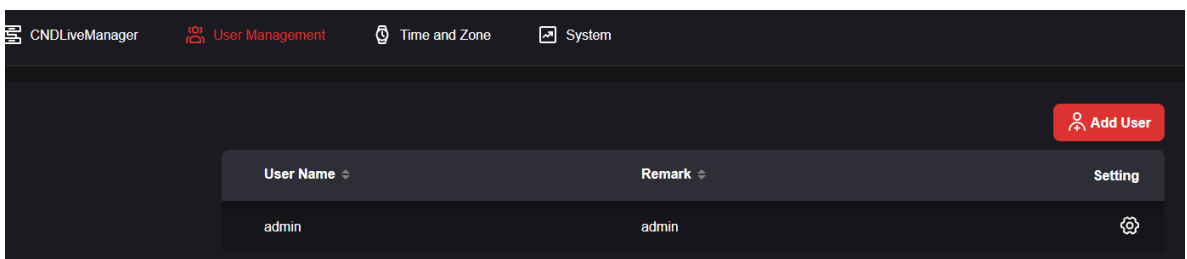

**Adding a user:** To add a new user, follow the steps below.

- 1) Click the "add user" button at the top of the screen.
- 2) Display input fields to enter a username, nickname and password.
- 3) Enter the new user's information.
- 4) After confirming that there are no errors, click the "apply" button.
- 5) The system will save the new user information and create a new user account.

**User list:** Below the add user button is the user List, which displays the following information.

- User name: Displays the user names of all users in the system.
- Nickname: Displays the user's nickname.
- Actions: Action options are provided underneath each user name, including "settings" and "delete".

**Edit user information:** To edit user information, follow the below steps:

- 1) Locate the target user in the user list.
- 2) Click the "settings" option below the username.
- 3) The system will jump to the user edit page and display the user information form.
- 4) Change the nickname and password in the form.
- 5) When you have completed your changes, click the "apply" button to save them.

**Deleting a user:** To delete a user, follow the steps below:

1. Locate the target user in the user list.
2. Click the "-" symbol icon below the user name.
3. A confirmation box will pop up asking whether to confirm the deletion operation.
4. Click "OK" to execute the deletion, or click "cancel" to cancel the deletion.



### Note

- Ensure that best security practices are followed when adding and editing user information, such as using strong passwords and updating passwords regularly.
- Before performing the deletion operation, be sure to confirm that the user no longer needs access to the system to avoid unnecessary privilege leakage.

### 4.5.3. Time and zone

Setting the time and time zone of the device to ensure that the time on the device matches the local time is critical for logging and time-sensitive applications.

The screenshot displays the 'Time and Zone' configuration interface. At the top, there is a navigation bar with icons and labels for 'CNDLiveManager', 'User Management', 'Time and Zone' (highlighted in red), and 'System'. Below the navigation bar, the 'Time' section contains the following fields:

- Device Time:** A text input field containing '2024-11-07 09:26:11'.
- Mode:** A dropdown menu with 'Timing with current PC' selected.
- Time:** A text input field containing '2024-11-07 09:26:12'.
- Region and Position:** A dropdown menu with 'Asia/Shanghai (CST)' selected.

A red 'Set' button is located at the bottom right of the configuration area.

### Time synchronization methods

- 1) Calibration with PC: Allows users to synchronize the decoder's time with the connected computer's system time.
- 2) Customized time: Users can manually set the time of the decoder to meet specific needs or for testing.
- 3) NTP server synchronization: The decoder can automatically synchronize with Network Time Protocol (NTP) servers to ensure time accuracy and global consistency.

**Set button:** After completing the time settings, the user needs to click the "set" button to apply the changes and save the settings. This feature ensures the persistence of the configuration and prevents loss of settings due to power failure or other reasons.

### **Region and location**

To improve the interactivity and intuitiveness, the decoder provides a world map. Users can manually select a location on the map to quickly set the decoder's time zone and other location-related parameters.

After selecting a region or manually marking a location on the map, the user needs to click the "change time zone" button to apply the new time zone setting and save it. This ensures that the decoder's time zone matches the user's actual location, thus providing accurate time information.

#### **4.5.4. Systems**

The latest software update can be installed to improve device performance and fix known issues. Also, a reboot feature is provided to reboot the device and restore factory settings to fix faults.

Time and Zone System

Hardware Version 2.01

Software Version V1.00.0064

Serial Number d36f2037ca08fba0

Device Name Decode

File Name No File Selected

Upload **Select File** Only .bin file

**Update**

**Refactory**

Tips: This operation will reset all system settings to default values and the device will reboot.

**Reset**

**Reboot**

It takes about 30s to reboot the device.

**Reboot**

**Current software version:** Used to display the current software version. This information is crucial for users as it helps them to know the software status of the device and update it if necessary.

### Upgrade process:

**1) Upload software:** Users can upload new software by clicking the "select file" button. After clicking this button, a file manager interface will pop up, allowing users to select a software file from the local file system. Note that the uploaded file format should be ".bin", which is the software file format supported by D1.

**2) File name:** After selecting a software file, the file name will be displayed in the corresponding input field. If the user did not select any file in step 2, the field will

display "no file selected", reminding the user that a software file needs to be selected before the upgrade can proceed.

**3) Update:** After selecting the software file and confirming the file name, the upgrade button will light up to indicate that the software upgrade operation can be performed. If no file is selected, the update button will remain grayed out and unclickable to prevent users for attempting an incomplete upgrade operation.

**Restore factory settings function:** When this option is selected and executed, all configurations, passwords, network settings, etc. on the device will be reset to factory defaults and the device will reboot automatically. Usually used to resolve configuration errors or system failures.

#### **Operational steps:**

- 1) Access the device's setup or configuration menu.
- 2) Select the "restore factory settings" option.
- 3) The system will prompt a warning message to note that by restoring the factory settings, all configurations, passwords, networks, etc. of the device will be restored to their default values and the device will reboot.
- 4) Click the OK button to confirm and perform the factory reset.



#### **Note**

- Before performing a factory reset, make sure that this is the action you want to take, as all personalized settings and data will be erased.
- Restoring the factory settings may affect all calibrations or special configurations on the unit and should be done when necessary.
- In some cases, administrator rights or specific privileges may be required to perform this operation.

**Reboot:** When this option is selected and executed, the device will perform the normal shutdown process and then automatically reboot. The entire reboot process takes approximately 30 seconds. This feature ensures that the device is able to quickly return to normal operation in the event of a glitch or need, which helps to maintain the stability and performance of the device.

#### **Operational steps**



- 1) Access the device's setup or configuration menu.
- 2) Select the "reboot" option.
- 3) The system will prompt a warning message.
- 4) Click the "reboot" button to confirm and perform the reboot.

**Note**

- Before performing a reboot operation, make sure that this is the operation you want, as the device will shut down and reboot.
- A reboot may interrupt ongoing work or data transfer, so please do at the appropriate time.
- If the device is performing a critical task or update, it is recommended to wait for the task to complete before rebooting.
- The reboot operation may take some time to complete, please wait patiently for the device to reboot and enter normal operation.

## 5. Support

If you need more support, please contact the manufacture.

**Website:** [www.cndlive.com](http://www.cndlive.com)

**Telephone:** 86-0755-26888895

**Email:** [support@cndlive.com](mailto:support@cndlive.com)